



扫描二维码
关注康力电梯门户网站
Scan the QR code and pay attention to
CANNY ELEVATOR Portal Website



扫描二维码
关注康力电梯微信公众号
Scan the QR code and pay attention to
CANNY ELEVATOR WeChat Public Number

KONL® 康力电梯
CANNY ELEVATOR

KLF 嶺秀

自动扶梯

LINGSHOW ESCALATOR



康力电梯股份有限公司 CANNY ELEVATOR CO.,LTD.

◎地址：江苏省滨湖高新技术产业开发区康力大道888号
◎电话：0512-63290000
◎传真：0512-63293938
◎网址：www.canny-elevator.com
◎电子信箱：(国内) marketing@canny-elevator.com
(国外) export-canny@163.com
export@canny-elevator.com
◎400客户服务热线：400-188-2367
◎邮编：215213

◎Add: No.888, Kangli Road, FOHO New & Hi-Tech Industrial
Development Zone, Jiangsu Province, China.
◎Tel: +86-512-63290000 63297851
◎Fax: +86-512-63299709
◎URL: www.canny-elevator.com
◎E-mail: export-canny@163.com
export@canny-elevator.com
◎P.C: 215213

本书为一般信息类出版物，我们保留随时更改产品设计和说明的权利，所有图片和颜色可能与实物有所不同，请以实物为准。
康力电梯股份有限公司 © 版权所有 2016-V1.0版

嶺秀自动扶梯
Lingshow
Escalator

嶺秀风范 Lingshow Style



商场



酒店



写字楼

品质、科技、人性

康力嶺秀系列自动扶梯，集现代扶梯领域的前沿技术、多样化功能之大成，引领自动扶梯制造新潮流。在秉承康力电梯一贯的精湛科技基础上，更注重融合人性化的至高理念，蕴含对客户需求的细心体察，彰显科技智慧。

Quality \ Technology \ humanity

Lingshow escalator integrates the cutting-edge technology and diversified functions of modern escalator and leads the new trend of escalator manufacturing. On a consistent basis of superb technology, CANNY ELEVATOR pays more attention to adding the noble human-oriented concept, observing customer's needs carefully, and highlighting the technological wisdom.



细致关怀成就人性尊享 Meticulous Care Leads to Humane Glory

• 梯级警界灯

绿色荧光灯安装在上部和下部梯级踏板下，当两连接的梯级运行错开时，绿色荧光便从梯级的齿口中照出，以帮助乘客识别梯级进出水平段，提高乘梯安全。

Demarcation Lamp

Green fluorescent light is installed under the upper and lower step pedals. When two adjacent steps do not run at the same time, green fluorescent light will be shed over the tooth mouth of the step, to help passengers identify the horizontal section of step turnover and improve the riding safety.

• 大圆弧半径回转扶手导轨

匹配使用滚动群轮组，减少摩擦，延长扶手带的使用寿命。

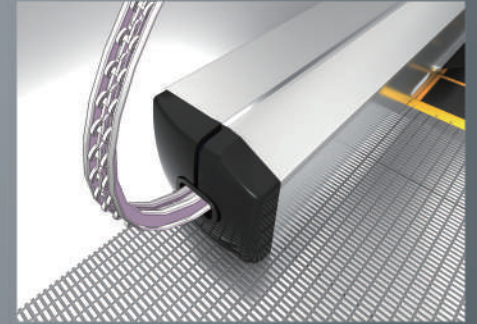

Large Radius Rotary Handrail Guide Rail

Large radius rotary handrail guide rail will work together with the rotary wheel set to reduce friction and prolong the life of the handrail.

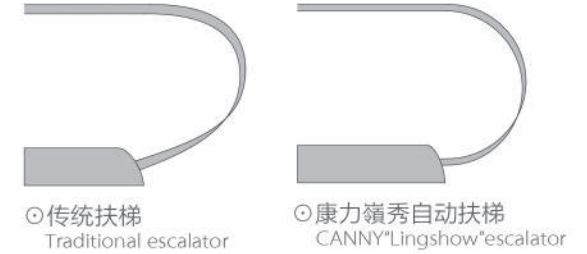

◎传统扶梯
Traditional escalator

◎康力嶺秀自动扶梯
CANNY Lingshow Escalator

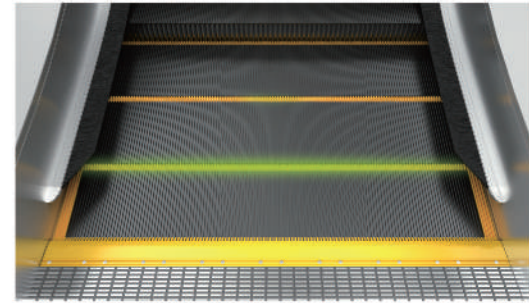

• 围裙板刷

防止乘客衣物被夹入围裙板和梯级侧边间隙中，以保护乘客安全。

Skirt Panel Brush

Prevent passengers' clothing from being caught by the apron board and the step side gap, in order to protect the safety of passengers.

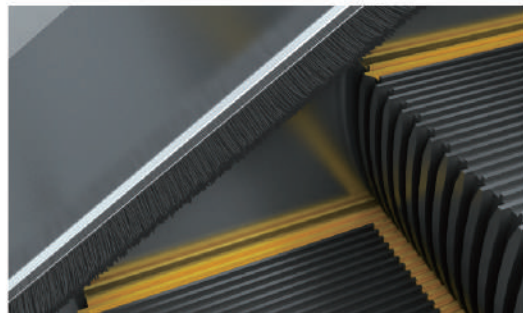

• 运行方向指示灯 (选配)

运行方向和禁行显示标识位于扶手带入口处，以显示运行或禁行指示，确保乘客安全自如地乘坐。

Running Direction Indicator (Optional)

Running direction and running-forbidden display identification is installed in the handrail entrance to show the running or running-forbidden instruction to ensure the safety of passengers.

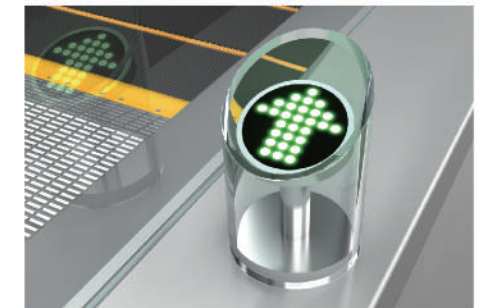



国际标准成就安全制造

- 扶手带入口保护装置: 如果有异物卡在橡胶头和扶手带之间, 其橡胶入口后面的安全开关就会启动, 使自动扶梯制停。
- 急停按钮: 当扶梯发生紧急故障时, 可按下急停按钮, 立刻停止扶梯运行, 防止更大的事故发生。

International Standard Leads to Safety Manufacturing

- Handrail inlet protection device: If a foreign matter is stuck between the rubber head and handrail, the safety switch behind the rubber entrance will work to stop the escalator.
- Emergency stop button: In case of emergency malfunction of the escalator, press the emergency stop button and immediately stop the escalator to avoid more accidents.



扶手带入口保护



急停按钮

LED

围裙照明 (选配)

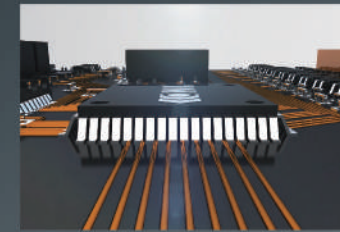

• 微机电脑板技术 (选配)

应用微机电脑板技术, 扩展性更强, 故障检测功能更加细化, 安全性能更高。

Micro-Computer Board Technology (Optional)

Apply micro computer technology board technology. The fault detection function is, thus greatly improve the safety performance.

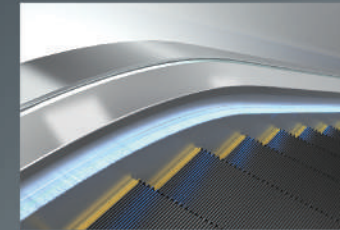

• 围裙照明 (选配)

围裙照明光线不仅美观大方, 同时又强调了扶梯在整栋大楼中的可见度, 使乘客乘坐更加舒适和安全。

Skirting Panel Lighting (Optional)

Apron lighting not only has beautiful light, but also stresses the escalator's visibility in the entire building, so that passengers will ride more comfortably and securely.

• 远程监控技术 (选配)

可以实时监测到扶梯上行、下行、故障和检修数据信号, 及时发现运行问题, 减少维护时间, 从而确保乘客安全。

Remote Monitoring Technology (Optional)

Able to conduct real-time monitoring over the data signals of the escalator's up, down, failure and repair can be conducted to facilitate maintenance and overhaul.





精雕细节成就卓然品质

- 桁架采用机器人焊接技术，大大提升制造工艺，具有品质精益、坚固耐用、美观大方等优点。
- 滚轮直径为 $\Phi 75$ ，能够有效减少轮压，梯级链条破断拉力更大，安全系数更高。
- 大高度高强度扶手护栏，护栏的防护高度达1000mm，提升了安全性能；同时新式加强型安全玻璃固定装置，使护栏具有较强的稳定性。
- 室外梯下机房安装水位检测感应器，能够自动检测水位情况，及时发现积水问题。（选配）
- 当环境温度过低而影响扶梯正常运行时，系统将自动启动加热装置，保证扶梯能够正常运行，也为乘客营造舒适的乘梯环境。（选配）

$\Phi 75$

滚轮直径

1000 mm

扶手护栏高

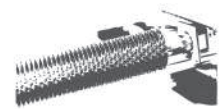

加热装置（选配）



梯级链
Step Chain

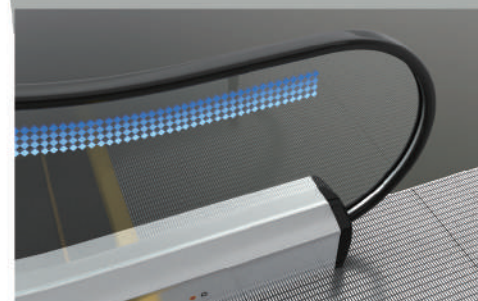

扶手护栏
Handrail Guardrail

Carved Details Create Superb Quality

- The truss adopts the robotic welding technology, which greatly enhance the manufacturing process. It has lean quality and it is sturdy and durable, beautiful and elegant.
- The diameter of the contact roller is $\Phi 75$. This can effectively reduce the wheel pressure, and improve the step chain breaking force dramatically. The safety factor will be higher.
- Large-height and high-intensity armrest guardrail is adopted. The protection height of the guardrail can amount to 1000 mm, which has improved safety performance. Meanwhile, new reinforced safety glass fixtures enable the fence to have strong stability.
- Outdoor escalator's lower machine room installs water level detection sensor. It can automatically detect the water level and find out ponding problems. (Optional)
- When the ambient temperature is so low that it affects the normal operation of the escalator, the system will automatically start the heating device to ensure the normal operation of the escalator and create a comfortable riding environment for passengers. (Optional)



机器人焊接
Robotic Welding

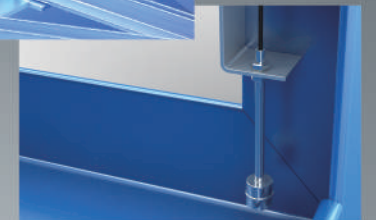

水位检测感应器（选配）
Water Level Detection Sensor (Optional)



绿色科技成就环保先锋

- 采用PLC控制自动加油润滑系统，实现了在扶梯运行过程中给传动链理想的自动润滑，延长传动机构的使用寿命。
- 所有照明设备都采用LED照明技术，与传统灯泡相比，节能高达80%。
- 室外梯特别设计的油水分离器，将雨水通过分离器排出，油污进行定期清洗，减少油污，保护环境。(选配)
- 变频控制技术：康力全新设计的变频器保证待机运行模式下速度调节的平稳，并进一步降低低速运行所需的能耗，确保不同客流情况下自动扶梯更高的节能效果。(选配)

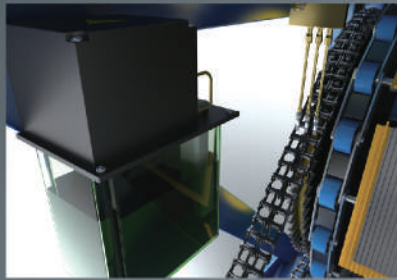

自动加油润滑系统
Automatic Oiling & Lubrication System

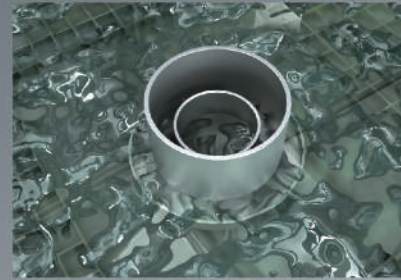

油水分离器 (选配)
Oil-Water Separator (Optional)

Green Technology Creates Environmental Pioneer

- PLC-controlled automatic oiling and lubrication system is able to give ideal automatic oiling to the transmission chairs, thus extending the life of the transmission mechanism.
- All lighting equipment uses LED lighting technology. Compared with traditional bulbs, it can save up to 80% of the energy.
- The oil-water separator is specially designed for outdoor escalators. The rainwater is discharged through the separator and the oil is cleaned regularly to reduce oil and protect the environment. (Optional)
- Frequency control technology: CANNY's newly designed inverters guarantee a steady speed adjustment in the standby mode and further reduce the energy consumption required for low speed operation. Accordingly, more energy can be saved regardless of different passenger flows. (Optional)

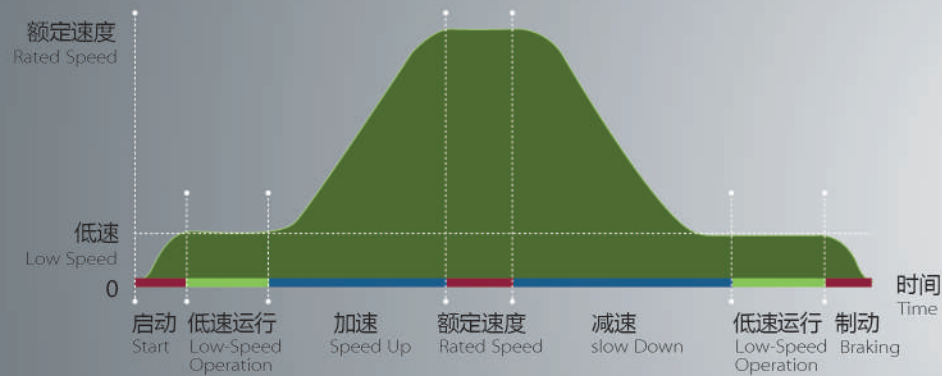

变频控制技术示意图 (选配)
Inverter Control Technology Diagram (Optional)

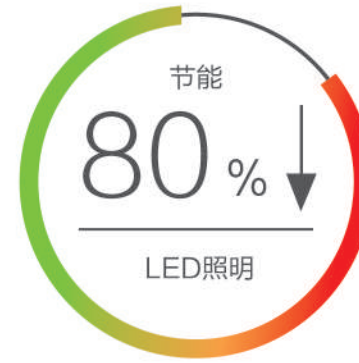

围裙板照明 (选配)
Skirting Panel Lighting (Optional)

扶手照明 (选配)
Handrail Lighting (Optional)

梯级照明
Step Lighting

梳齿照明 (选配)
Comb Teeth Lighting (Optional)



潮流风尚，流动风景

Fashion Trends, Mobile Landscape

扶手带颜色 Handrail Color

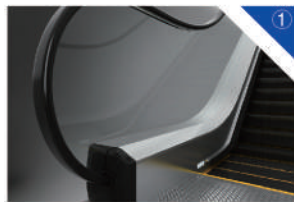

黑色 (标配)
Black (Standard)

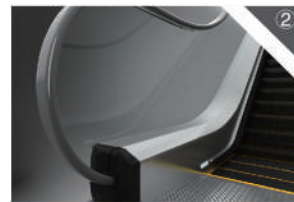

灰色 (选配)
Gray (Optional)

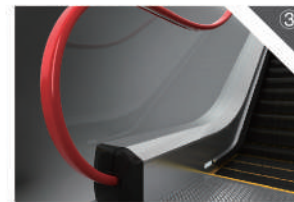

红色 (选配)
Red (Optional)

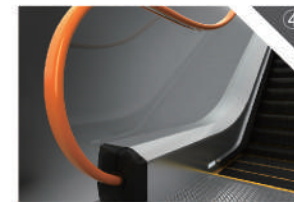

橙色 (选配)
Orange (Optional)

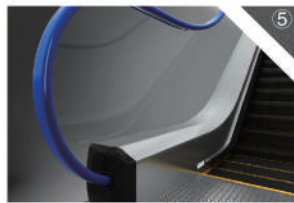

蓝色 (选配)
Blue (Optional)

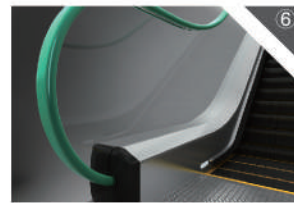

浅绿蓝 (选配)
Shallow Bluish Green (Optional)

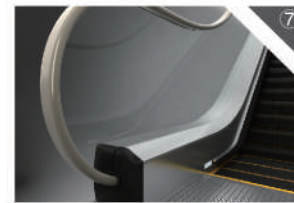

浅褐色 (选配)
Light Brown (Optional)

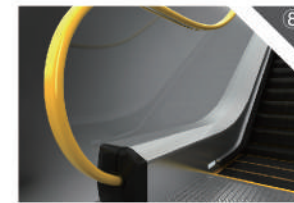

黄色 (选配)
Yellow (Optional)

护壁板颜色 Balustrade Color

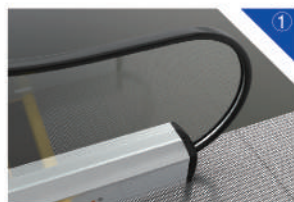

透明 (标配)
Transparent (Standard)

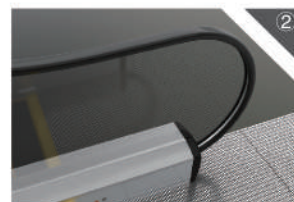

灰色 (选配)
Gray (Optional)



古铜色 (选配)
Bronze (Optional)

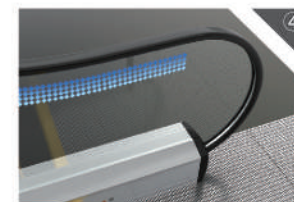

透明带丝印 (选配)
Transparent Silk Screen (Optional)

围裙照明 Skirting Lighting

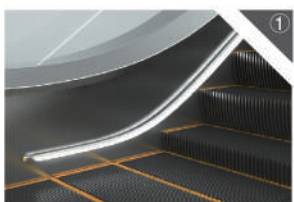

白色 (选配)
White (Optional)

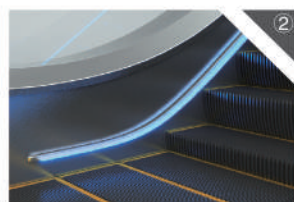

蓝色 (选配)
Blue (Optional)

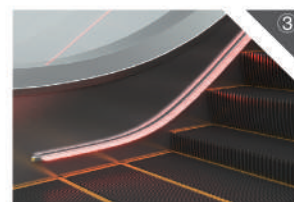

红色 (选配)
Red (Optional)

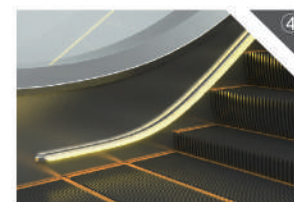

黄色 (选配)
Yellow (Optional)

梯级 Step

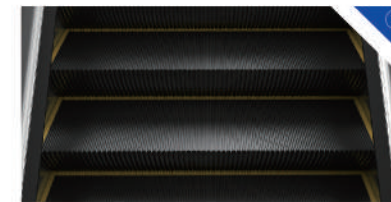

黑色不锈钢C型塑料边框 (室内梯标配)
Black Stainless Steel C-Type Plastic Frame
(Standard Configuration for Indoor escalator)

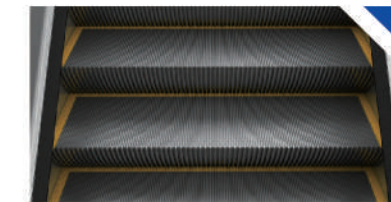

银灰色铝合金C型边框 (室外梯标配)
Silver Grey Aluminum Alloy
(Standard Configuration for Outdoor escalator)

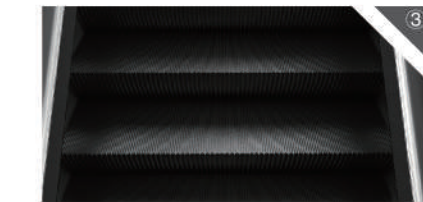

黑色铝合金 (选配)
Black Aluminum Alloy (Optional)

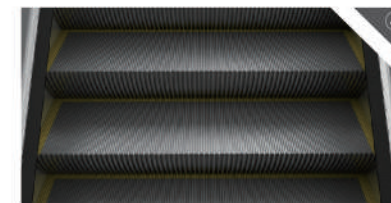

边框喷涂C型 (选配)
Frame Spraying C-Type (Optional)

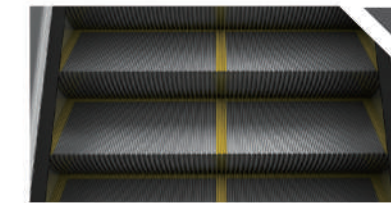

边框喷涂E型 (选配)
Frame Spraying E-Type (Optional)

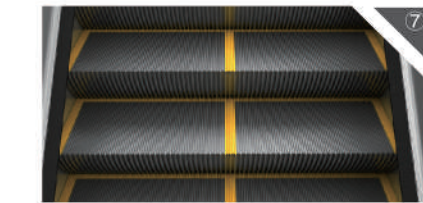

边框黄色塑料E型 (选配)
Frame Yellow Plastic E-Type (Optional)

梳齿 Comb Teeth

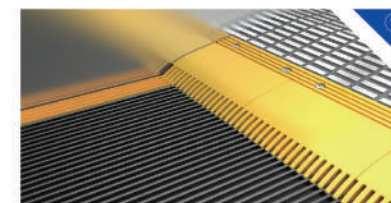

黄色塑料 (标配)
Yellow Plastic (Standard)

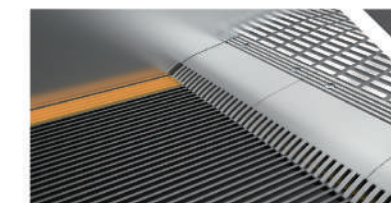

铝 (选配)
Aluminum (Optional)

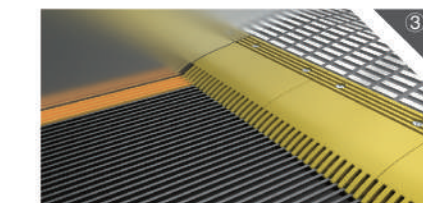

铝表面黄色喷漆 (选配)
Aluminum Surface Yellow Paint (Optional)

前沿板 Landing Plate



不锈钢方块贴片 (标配)
Stainless Steel Square Patch (Standard)



铝合金贴片 (选配)
Aluminum Patch (Optional)

运行方向指示灯 Running Direction Indicator



透明塑料LED显示 (选配)
Transparent Plastic LED Display (Optional)



黑色塑料点阵显示 (选配)
Black Plastic Dot Matrix Display (Optional)

注：图片系电脑绘制，可能与实际略有不同，以实物为准。

Note: Pictures have been drawn by computer. It might be slightly different from actual colors. Please take real product as criterion.

KLF-K/KLF-M
F型自动扶梯
F-Type Escalator

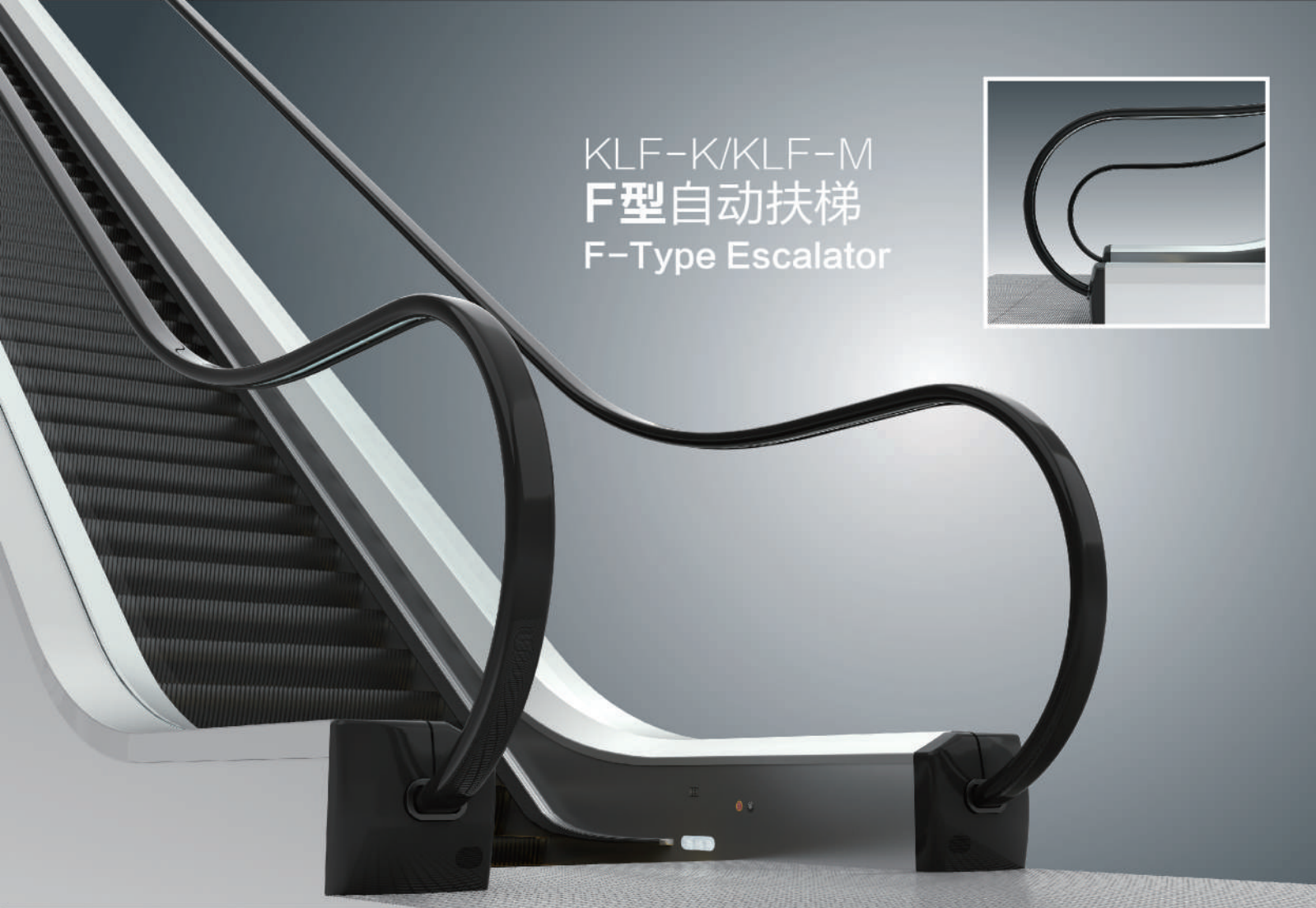
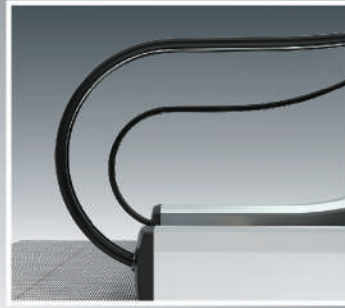

自动扶梯规格表 Specification Table

型号 Model	KLF-K / BK (室内)	KLF-M / BM (室内)	KLF-K / BK (室外)	KLF-M / BM (室外)
倾斜角度 Angle of inclination	35° /30°	35° /30°	35° /30°	35° /30°
梯级宽度 (mm) Step width (mm)	1000/800/600	1000/800/600	1000/800/600	1000/800/600
运行速度m/s Running speed (m/s)	0.5	0.5	0.5	0.5
水平梯级数 Horizontal step number	2	3	2	3
最大提升高度m Rise height H(m)	≤6	≤6/≤10	≤6	≤6/≤10

自动扶梯配置表 Configuration Table

型号 Model	KLF-K/KLF-M (室内)	KLF-BK/KLF-BM (室内)
踏板、梳齿板类型(标配) Types of Pedals and Comb Plate(Standard)	SUS430不锈钢贴片楼层盖板 SUS430 Stainless Steel Patch Floor Cover	SUS430不锈钢贴片楼层盖板 SUS430 Stainless Steel Patch Floor Cover
踏板、梳齿板类型(选配) Types of Pedals and Comb Plate(Optional)	全铝合金楼层盖板/铝合金贴片楼层盖板/SUS304不锈钢贴片楼层盖板 All Aluminum Floor Cover / Aluminum Patch Floor Cover / SUS430 Stainless Steel Patch Floor Cover	全铝合金楼层盖板/铝合金贴片楼层盖板/SUS304不锈钢贴片楼层盖板 All Aluminum Floor Cover / Aluminum Patch Floor Cover / SUS430 Stainless Steel Patch Floor Cover
围裙板(标配) Skirting Panel(Standard)	SUS430 不锈钢围裙板 SUS430 Stainless Steel Skirting Panel	SUS430 不锈钢围裙板 SUS430 Stainless Steel Skirting Panel
围裙板(选配) Skirting Panel(Optional)	SUS304 不锈钢围裙板 SUS304 Stainless Steel Skirting Panel	SUS304 不锈钢围裙板 SUS304 Stainless Steel Skirting Panel
梯级(标配) Step(Standard)	黑色不锈钢 Black Stainless Steel	黑色不锈钢 Black Stainless Steel
梯级(选配) Step(Optional)	铝合金黑色/铝合金银灰色 Black Aluminum Alloy / Silver Grey Aluminum Alloy	铝合金黑色/铝合金银灰色 Black Aluminum Alloy / Silver Grey Aluminum Alloy
扶手带(标配) Handrail(Standard)	黑色 Black	黑色 Black
扶手带(选配) Handrail(Optional)	黑色/彩色 Black/color	黑色/彩色 Black/color
扶手导轨(标配) Handrail Guide(Standard)	SUS430不锈钢扶手支架 SUS430 Stainless Steel Handrail Brackets	铝合金扶手支架 Aluminum Handrail Brackets
扶手导轨(选配) Handrail Guide(Optional)	SUS304不锈钢扶手支架 SUS304 Stainless Steel Handrail Brackets	—
护壁板(标配) Balustrade Panel(Standard)	10mm 钢化无色安全玻璃 10 mm Colorless Toughened Tempering Safety Glass	10mm 钢化无色安全玻璃 10 mm Colorless Toughened Tempering Safety Glass
护壁板(选配) Balustrade Panel(Optional)	—	—

KLF-BK/KLF-BM
B型自动扶梯
B-Type Escalator



型号 Model	KLF-K/KLF-M (室外)	KLF-BK/KLF-BM (室外)
踏板、梳齿板类型(标配) Types of Pedals and Comb Plate(Standard)	SUS304不锈钢贴片楼层盖板 SUS430 Stainless Steel Patch Floor Cover	SUS304不锈钢贴片楼层盖板 SUS430 Stainless Steel Patch Floor Cover
踏板、梳齿板类型(选配) Types of Pedals and Comb Plate(Optional)	全铝合金楼层盖板/铝合金贴片楼层盖板 All Aluminum Floor Cover / Aluminum Patch Floor Cover	全铝合金楼层盖板/铝合金贴片楼层盖板 All Aluminum Floor Cover / Aluminum Patch Floor Cover
围裙板(标配) Skirting Panel(Standard)	SUS304 不锈钢围裙板 SUS304 Stainless Steel Skirting Panel	SUS304 不锈钢围裙板 SUS304 Stainless Steel Skirting Panel
围裙板(选配) Skirting Panel(Optional)	—	—
梯级(标配) Step(Standard)	铝合金银灰色 Silver Grey Aluminum Alloy	铝合金银灰色 Silver Grey Aluminum Alloy
梯级(选配) Step(Optional)	铝合金黑色 Black Aluminum Alloy	铝合金黑色 Black Aluminum Alloy
扶手带(标配) Handrail(Standard)	国际知名品牌 (黑色) International Well-known Brand (black)	国际知名品牌 (黑色) International Well-known Brand (black)
扶手带(选配) Handrail(Optional)	国际知名品牌 (彩色) International Well-known Brand (color)	国际知名品牌 (彩色) International Well-known Brand (color)
扶手导轨(标配) Handrail Guide(Standard)	SUS304不锈钢扶手支架 SUS304 Stainless Steel Handrail Brackets	铝合金 Aluminum Alloy
扶手导轨(选配) Handrail Guide(Optional)	—	—
护壁板(标配) Balustrade Panel(Standard)	10mm 钢化无色安全玻璃 10 mm Colorless Toughened Tempering Safety Glass	10mm 钢化无色安全玻璃 10 mm Colorless Toughened Tempering Safety Glass
护壁板(选配) Balustrade Panel(Optional)	—	—

安全装置

Safety Device

标准安全装置	Standard Safety Device
1 围裙板保护	Skirting protection
2 梯级照明	Step gap lighting
3 紧急停止按钮	Emergency stop button
4 梯级缺失保护	Step loss protection
6 梳齿板安全保护装置	Comb plate safety protection device
7 制动器保护	Safety brake
8 驱动链断裂保护	Broken drive-chain protection
9 电器回路保护	Electrical circuit protection
10 马达超载保护	Motor overload protection
11 缺相错相保护	Phase error or failure protection
12 超速保护	Over-speed protection
13 非操作逆转保护	Unintentional reversal of the direction of travel
14 检修安全开关	Safety switch inspection

标准安全装置	Standard Safety Device
15 启动警铃装置	Alarm device start
16 梯级塌陷保护装置	Step sagging protection device
17 警戒线	Warning line
18 扶手带速度监控	Handrail speed monitor
19 围裙板刷	Skirting brush
20 扶手带入口保护	Handrail inlet
21 梯级链断裂保护	Broken step chain protection

选配安全装置	Selective Safety Devices
5 附加制动器 (H > 6m时必须配备)	Auxiliary brake (Standard configuration when H > 6m)
22 下部机房排水 (室外型)	Lower machine room drain (Outdoor type)

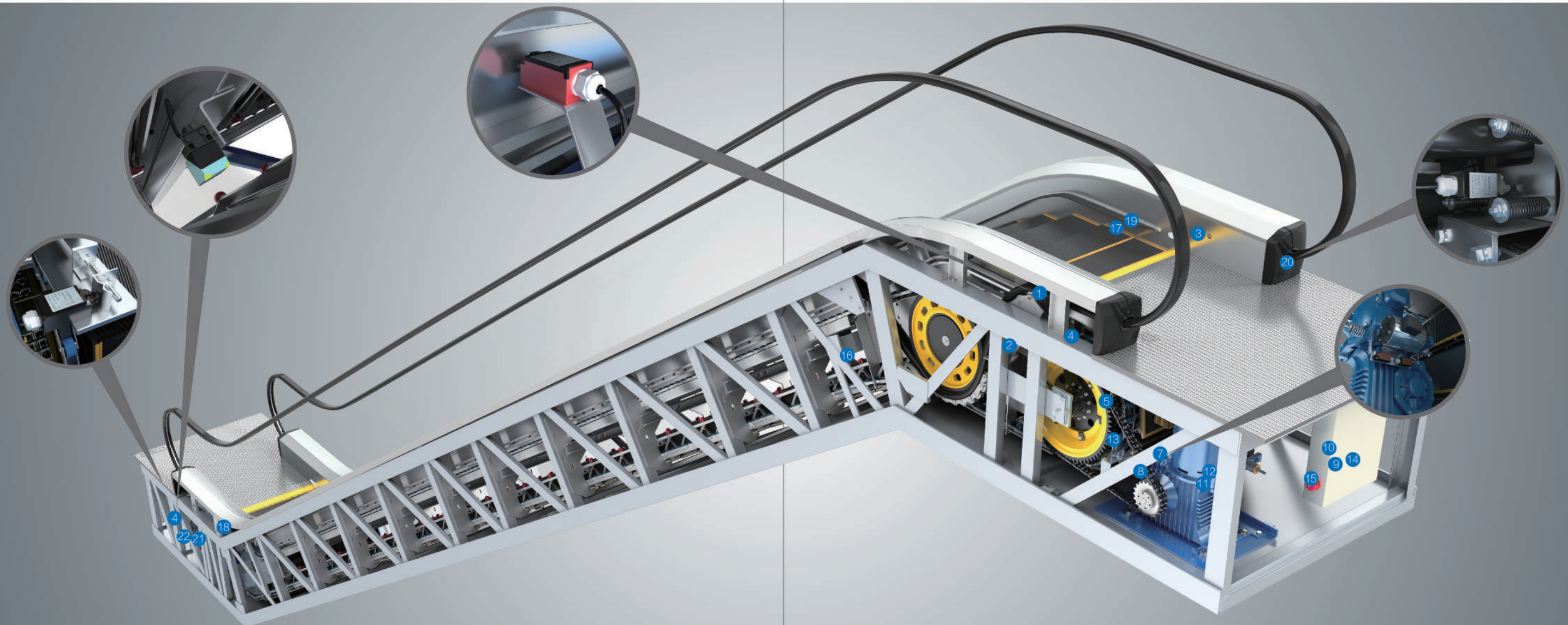

土建参数

General Layout Drawing Data

KLF 30° 单列 室内 **Single (Indoor)**
 KLF30-60M / 80M / 100M 3个水平梯级 Three horizontal steps H≤10m

KLF 30° 并列 室内 **Parallel (Indoor)**
 KLF30-60K / 80K / 100K 2个水平梯级 Two horizontal steps H≤6m

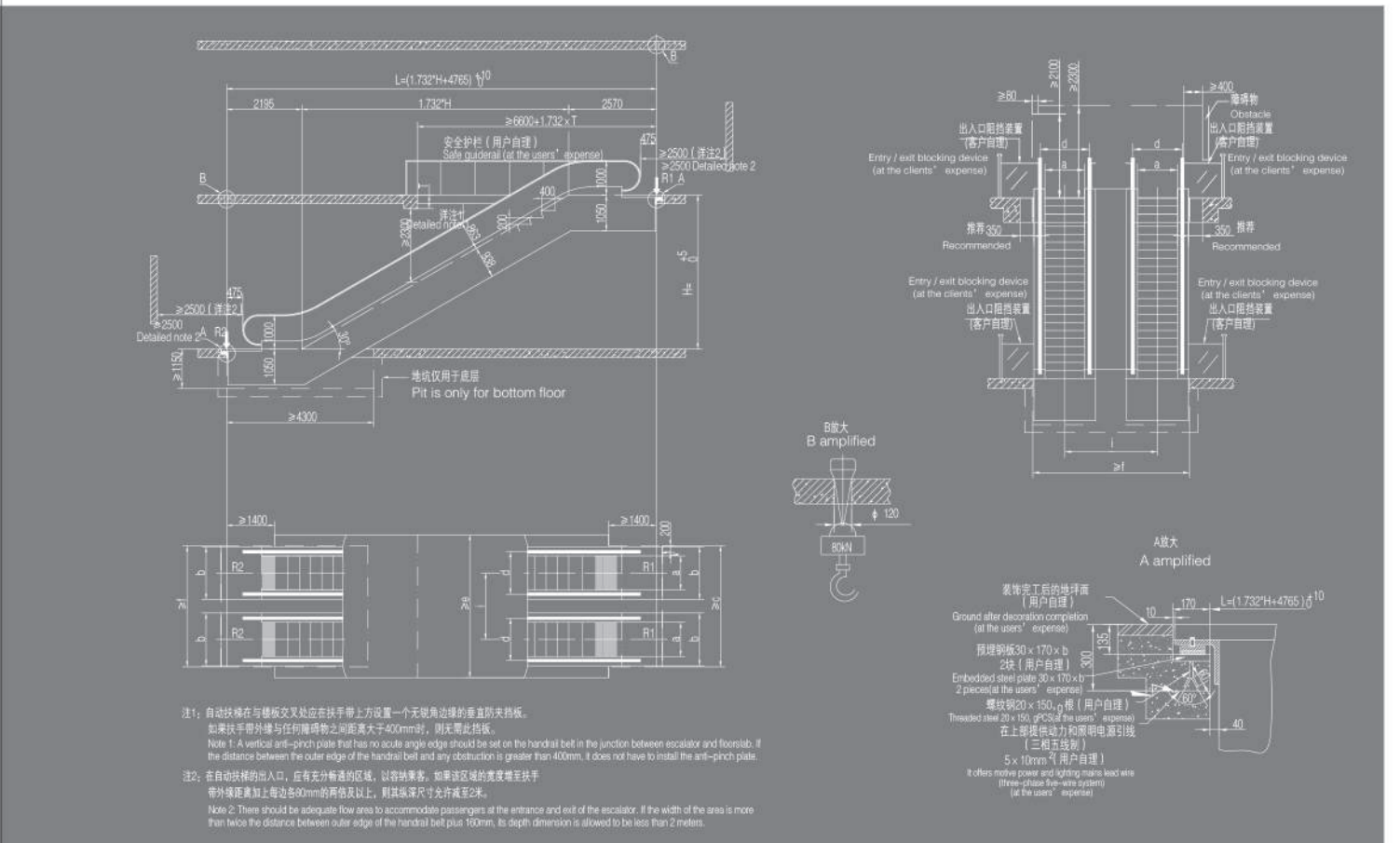
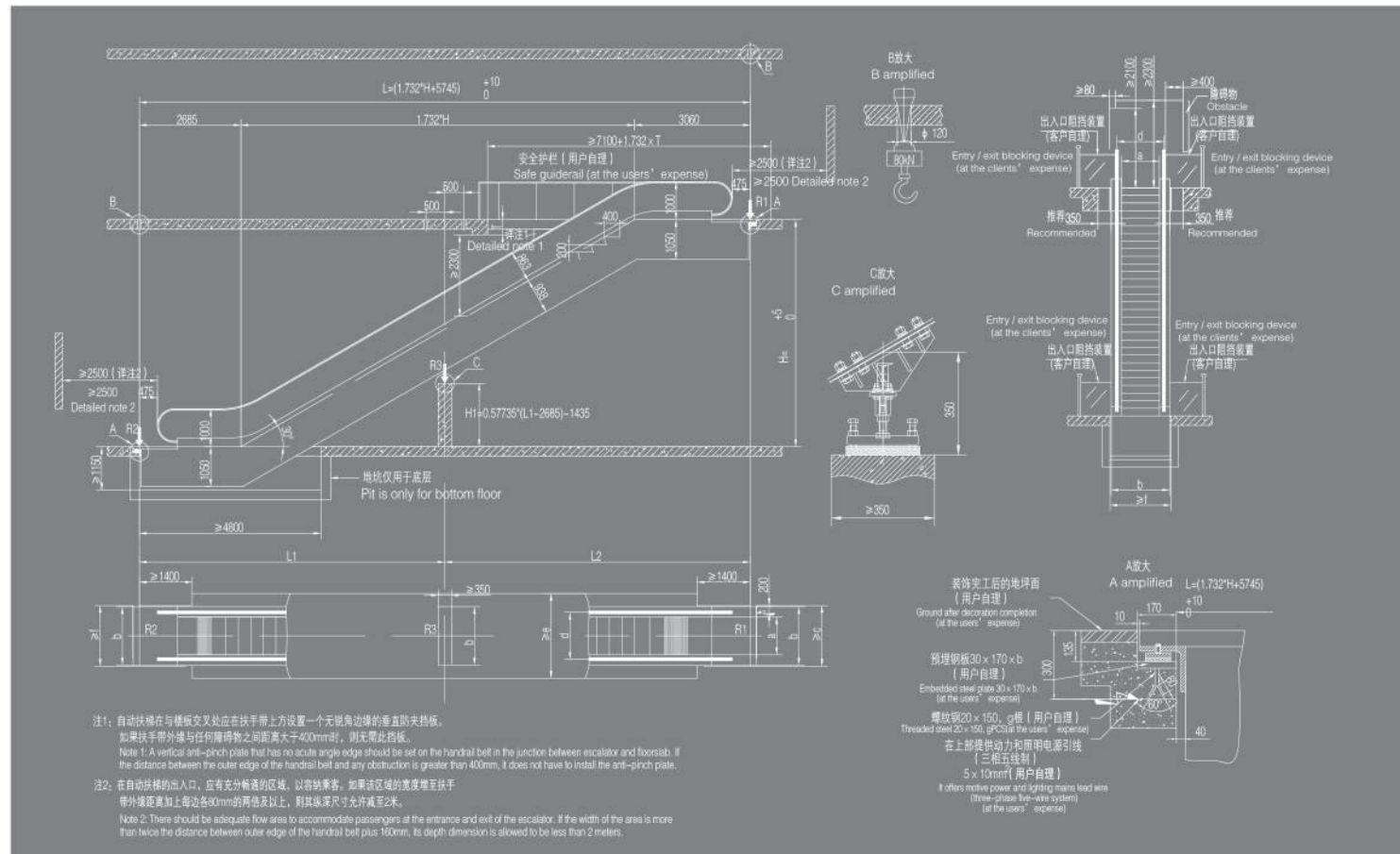

标准规格及尺寸

Standard specification and dimension

梯级宽度 Step width	a	KLF30-60M 600	KLF30-80M 800	KLF30-100M 1000
装饰宽度 Decoration width	b	1140	1340	1540
土建开口宽度 Construction layout opening width	c	1200	1400	1600
扶手间距 Handrail spacer	d	838	1038	1238
安全土建开口宽度 Safety construction layout opening width	e	1718	1918	2118
土建开口宽度 Construction layout opening width	f	1200	1400	1600
螺纹钢数量 (根) Threaded steel quantity (PCS)	g	4	5	6
运行速度 (m/s) Running speed (m/s)		0.5	0.5	0.5
倾斜角 (°) Degree of inclination (°)		30	30	30

说明

本图适用于10M及以下单台安装扶梯的土建施工之用。
 选用梯级宽度600mm或选用双驱动，桁架上部必须延长550mm；当H≤5.7m时，取消中间支撑。
 销售部门应将本图一式4份提供用户，其中2份经用户盖章，签字后返回技术科。
 尺寸单位为mm，个别尺寸可能有更改，如有更改，恕不另行通知。

支反力

Reacting force

R1(kN)	梯级宽度 600	梯级宽度 800	梯级宽度 1000
R2(kN)	4.1×L2+15.5	4.5×L2+16.1	5×L2+17.5
R3(kN)	4.1×L1+7.8	4.5×L1+7.8	5×L1+8.5
	4.25×L+9.5	4.5×L+10.5	5.2×L+11.5

L, L1, L2单位为m, L1, L2都不超过15m,
 L, L1, L2unit is m.L1, L2 will not exceed 15m.

Description

This drawing is fit for the construction of 10m and below single mounted escalators.
 It chooses 600mm wide step or double-drive. Upper truss shall extend 550mm more. When H≤5.7m, middle support shall be cancelled.
 The Sales Dept. needs to make four copies of this drawing. Two copies shall return to the Technical Section after being stamped and signed by the users.
 Size unit: mm. It is possible to change some individual sizes. If there is any alterations, advance notice won't be given then.

标准规格及尺寸

Standard specification and dimension

梯级宽度 Step width	a	KLF30-60K 600	KLF30-80K 800	KLF30-100K 1000
装饰宽度 Decoration width	b	1140	1340	1540
土建开口宽度 Construction layout opening width	c	2740	3140	3540
扶手间距 Handrail spacer	d	838	1038	1238
安全土建开口宽度 Safety construction layout opening width	e	3258	3658	4058
土建开口宽度 Construction layout opening width	f	2740	3140	3540
螺纹钢数量 (根) Threaded steel quantity (PCS)	g	4	5	6
扶梯中心距 Escalator center distance	i	1540	1740	1940
运行速度 (m/s) Running speed (m/s)		0.5	0.5	0.5
倾斜角 (°) Degree of inclination (°)		30	30	30

说明

本图适用于6M及以下双台安装扶梯的土建施工之用。
 选用梯级宽度600mm，桁架上部必须延长550mm。
 销售部门应将本图一式4份提供用户，其中2份经用户盖章，签字后返回技术科。
 尺寸单位为mm，个别尺寸可能有更改，如有更改，恕不另行通知。

支反力及功率

Reacting force and power

R1(kN)	梯级宽度 600	梯级宽度 800	梯级宽度 1000
R2(kN)	3.5×L+15.5	4×L+17	4.5×L+18.5
提升高度 Rising height	3000 3500	4000 4800	5000 5500 6000
电机功率1000 Machine power	5.5kW	8kW	11kW
电机功率800 Machine power	5.5kW	5.5kW 8kW	8kW
电机功率600 Machine power	5.5kW	5.5kW	5.5kW

L单位为m, L unit is m.

Description

This drawing is fit for the construction of 6m and below double-set mounted escalators.
 If it chooses 600mm of the step width, it should prolong 550mm of the upper truss.
 The Sales Dept. needs to make four copies of this drawing. Two copies shall return to the Technical Section after being stamped and signed by the users.
 Size unit: mm. It is possible to change some individual sizes. If there is any alterations, advance notice won't be given then.

土建参数

General Layout Drawing Data

KLF 30° 并列 室内 Parallel (Indoor)
 KLF30-60M / 80M / 100M 3个水平梯级 Three horizontal steps H≤10m

KLF 30° 单列 室外 Single (Outdoor)
 KLF30-60K / 80K / 100K 2个水平梯级 Two horizontal steps H≤6m

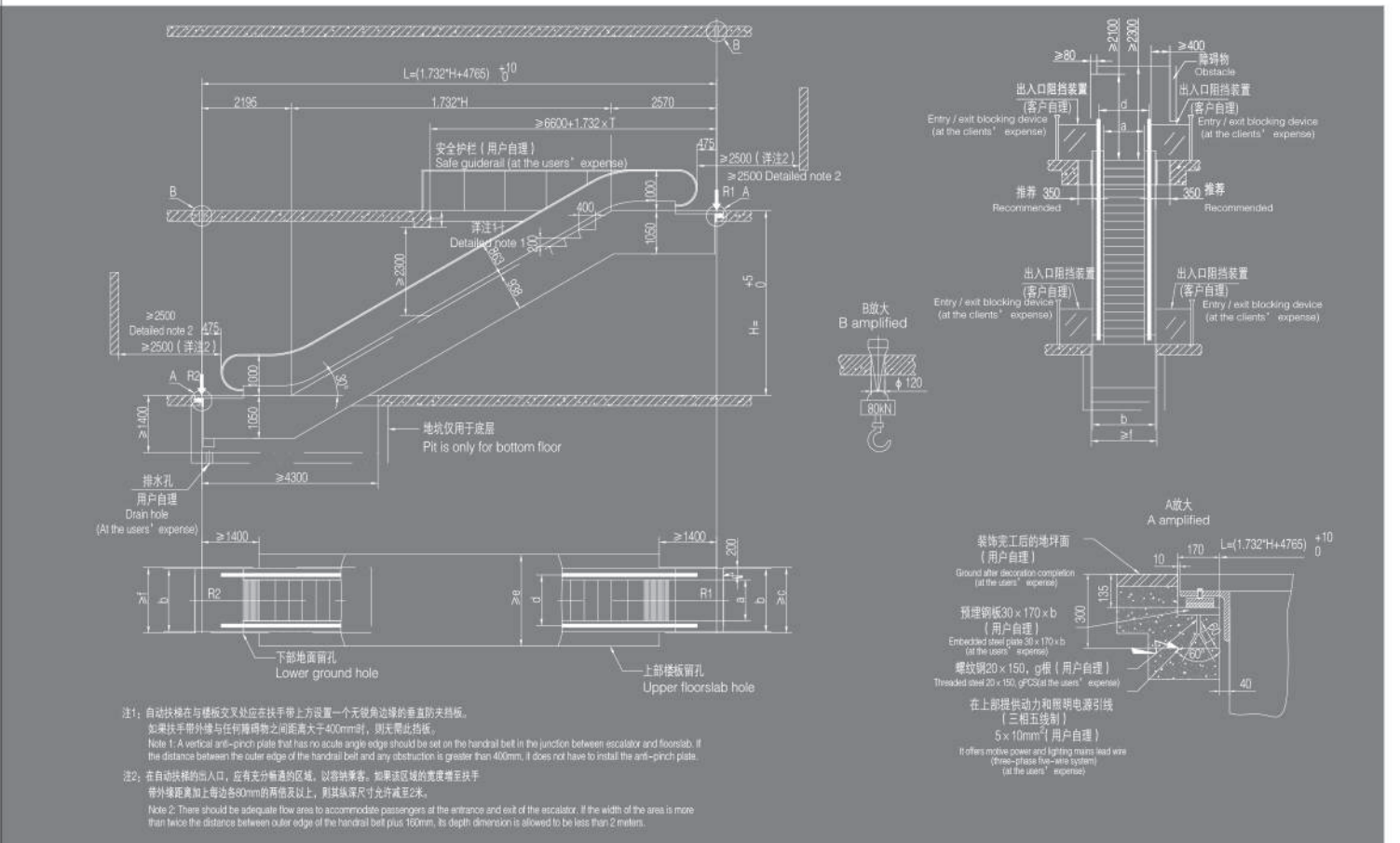
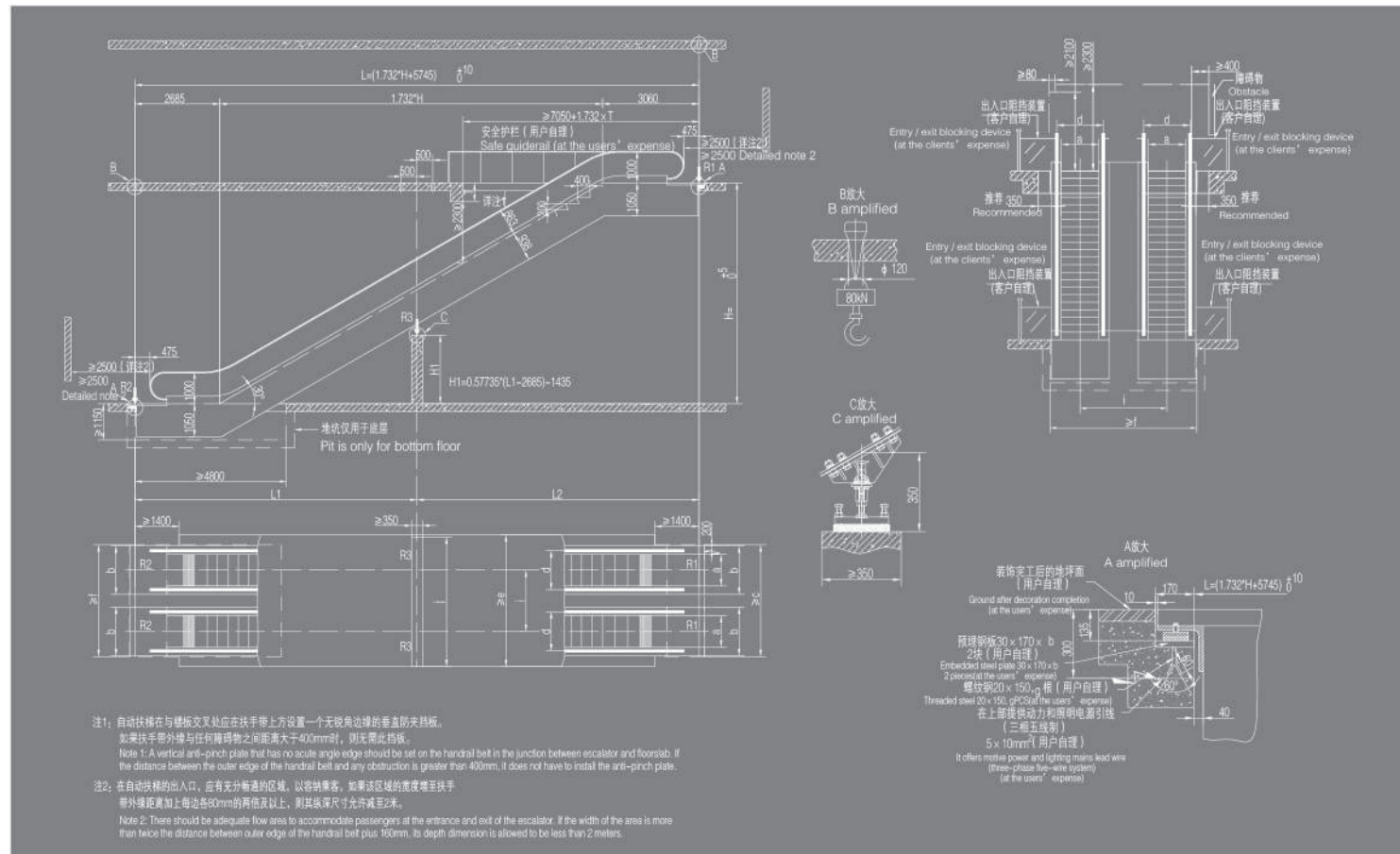

标准规格及尺寸

Standard specification and dimension

梯级宽度 Step width	a	KLF30-60M 600	KLF30-80M 800	KLF30-100M 1000
装饰宽度 Decoration width	b	1140	1340	1540
土建开口宽度 Construction layout opening width	c	2740	3140	3540
扶手间距 Handrail spacer	d	838	1038	1238
安全土建开口宽度 Safety construction layout opening width	e	3258	3658	4058
土建开口宽度 Construction layout opening width	f	2740	3140	3540
螺纹钢数量 (根) Threaded steel quantity (PCS)	g	4	5	6
扶梯中心距 Escalator center distance	i	1540	1740	1940
支承座宽度 Supporting base width	j	2680	3080	3480
运行速度 (m/s) Running speed (m/s)		0.5	0.5	0.5
倾斜角 (°) Degree of inclination (°)		30	30	30

支反力

Reacting force

	梯级宽度 600	梯级宽度 800	梯级宽度 1000
R1 (kN)	4.1×L ₂ +15.5	4.5×L ₂ +16.1	5×L ₂ +17.5
R2 (kN)	4.1×L ₁ +7.8	4.5×L ₁ +7.8	5×L ₁ +8.5
R3 (kN)	4.25×L+9.5	4.5×L+10.5	5.2×L+11.5

L, L₁, L₂单位为m, L₁, L₂都不超过15m,
 L, L₁, L₂unit is m. L₁, L₂ will not exceed 15m.

说明

本图适用于10M及以下双台安装扶梯的土建施工之用。
 选用梯级宽度600mm或选用双驱动, 桁架上部必须延长550mm; 当H≤5.7m时, 取消中间支撑。
 销售部门应将本图一式4份提供用户, 其中2份经用户盖章, 签字后返回技术科。
 尺寸单位为mm, 个别尺寸可能有更改, 如有更改, 恕不另行通知。

Description

This drawing is fit for the construction of 10m and below double-set mounted escalators.
 It chooses 600mm wide step or double-drive. Upper truss shall extend 550mm more. When H≤5.7m, middle support shall be cancelled.
 The Sales Dept. needs to make four copies of this drawing. Two copies shall return to the Technical Section after being stamped and signed by the users.
 Size unit: mm. It is possible to change some individual sizes. If there is any alterations, advance notice won't be given then.

标准规格及尺寸

Standard specification and dimension

梯级宽度 Step width	a	KLF30-60K 600	KLF30-80K 800	KLF30-100K 1000
装饰宽度 Decoration width	b	1140	1340	1540
土建开口宽度 Construction layout opening width	c	1200	1400	1600
扶手间距 Handrail spacer	d	838	1038	1238
安全土建开口宽度 Safety construction layout opening width	e	1718	1918	2118
土建开口宽度 Construction layout opening width	f	1200	1400	1600
螺纹钢数量 (根) Threaded steel quantity (PCS)	g	4	5	6
运行速度 (m/s) Running speed (m/s)		0.5	0.5	0.5
倾斜角 (°) Degree of inclination (°)		30	30	30

说明

本图适用于6M及以下单台安装扶梯的土建施工之用。
 选用梯级宽度600mm, 桁架上部必须延长550mm。
 销售部门应将本图一式4份提供用户, 其中2份经用户盖章, 签字后返回技术科。
 尺寸单位为mm, 个别尺寸可能有更改, 如有更改, 恕不另行通知。

支反力及功率

Reacting force and power

	梯级宽度 600	梯级宽度 800	梯级宽度 1000
R1 (kN)	3.5×L+15.5	4×L+17	4.5×L+18.5
R2 (kN)	3.5×L+10	4×L+11	4.5×L+11.5
提升高度 Rising height	3000 3500	4000 4800	5000 5500 6000
电机功率1000 Machine power	5.5kW	8kW	11kW
电机功率800 Machine power	5.5kW	5.5kW 8kW	8kW
电机功率600 Machine power	5.5kW	5.5kW	5.5kW

L单位为m. L unit is m.

Description

This drawing is fit for the construction of 6m and below single mounted escalators.
 If it chooses 600mm of the step width, it should prolong 550mm of the upper truss.
 The Sales Dept. needs to make four copies of this drawing. Two copies shall return to the Technical Section after being stamped and signed by the users.
 Size unit: mm. It is possible to change some individual sizes. If there is any alterations, advance notice won't be given then.

土建参数

General Layout Drawing Data

KLF 30° 单列 室外 Single (Outdoor)
 KLF30-60M / 80M / 100M 3个水平梯级 Three horizontal steps H≤10m

KLF 35° 单列 室内 Single (indoor)
 KLF35-60K / 80K / 100K 2个水平梯级 Two horizontal steps H≤6m

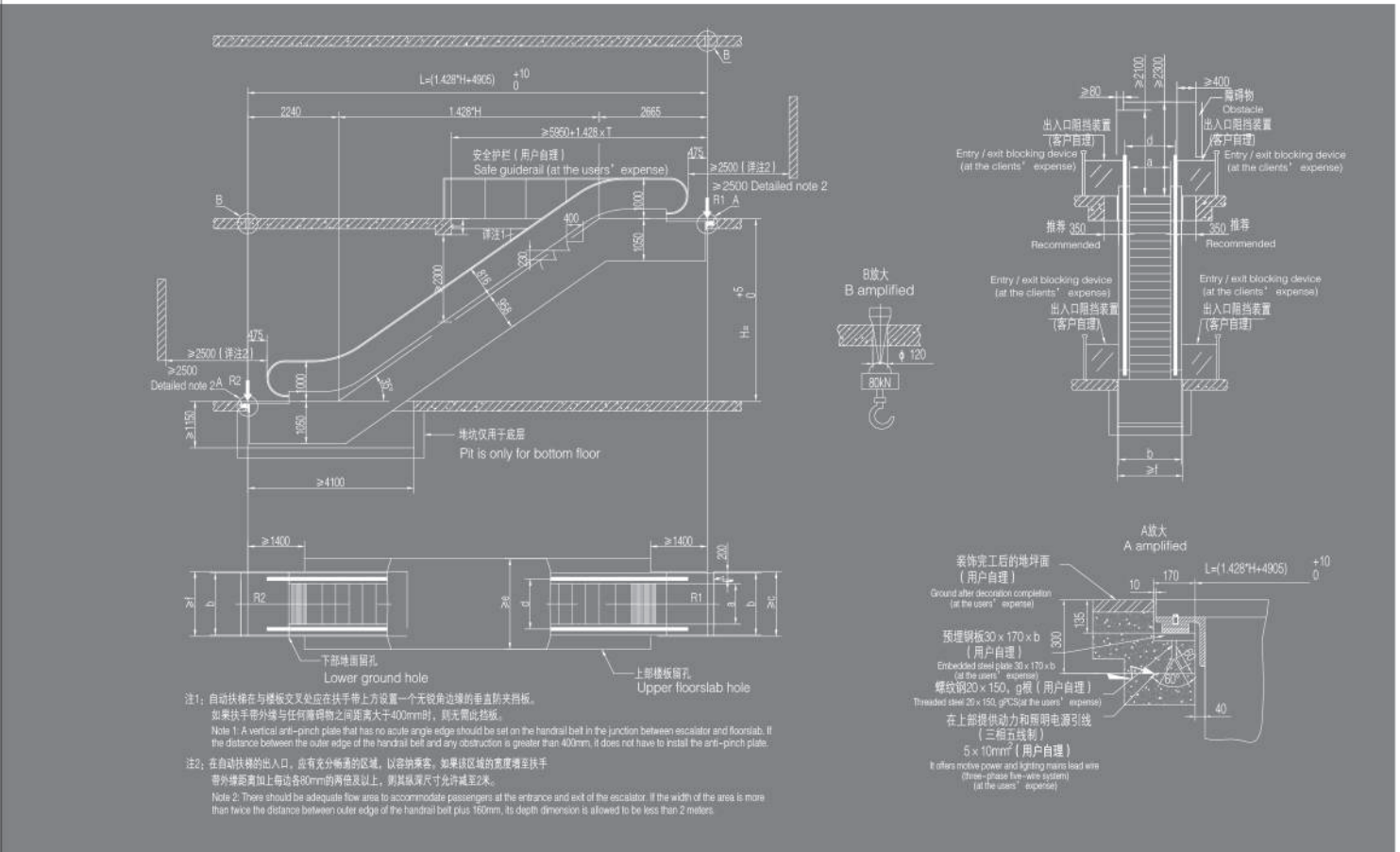
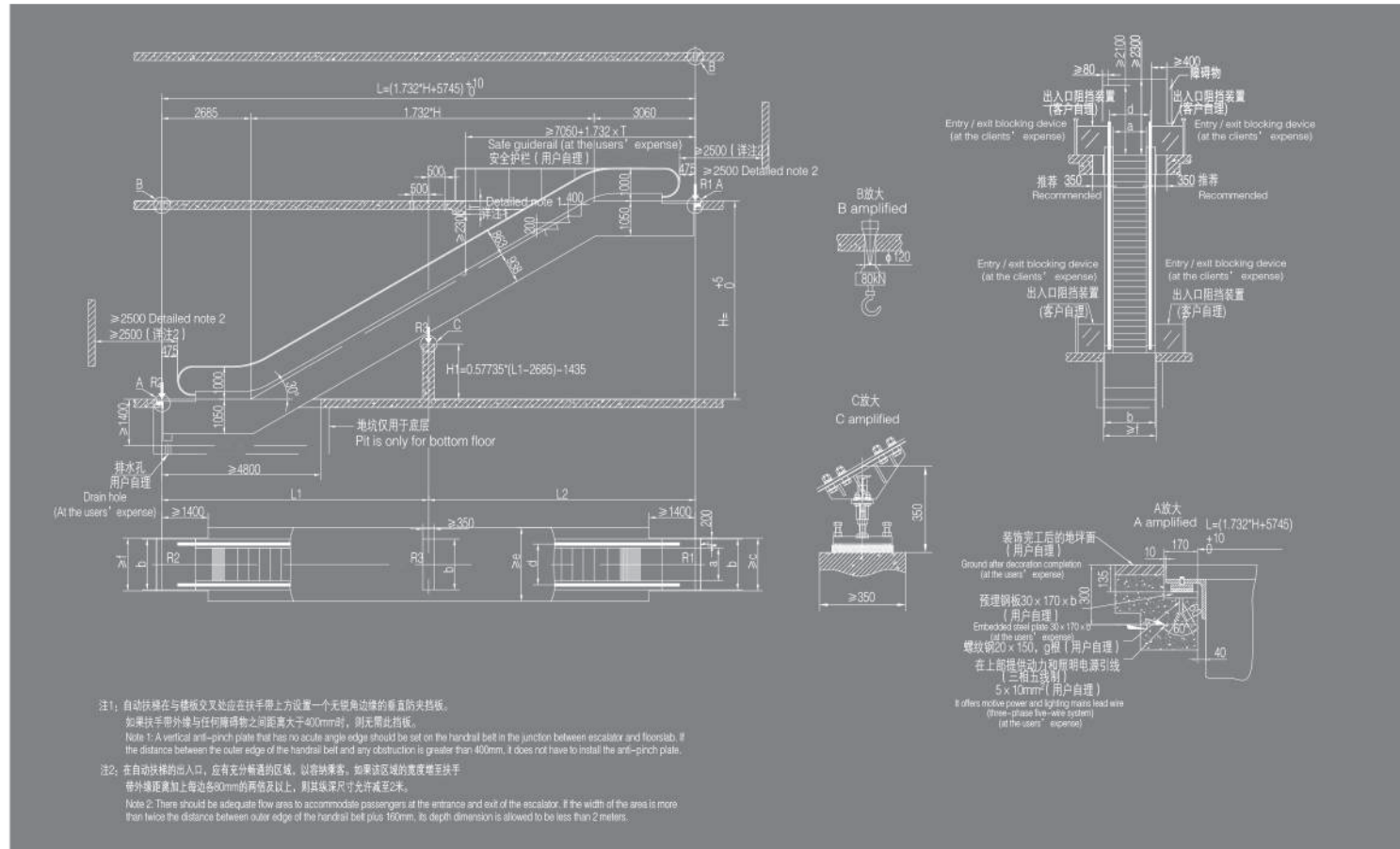

标准规格及尺寸

Standard specification and dimension

梯级宽度 Step width	a	KLF30-60M	600	800	1000
装饰宽度 Decoration width	b	KLF30-60M	1140	1340	1540
土建开口宽度 Construction layout opening width	c	KLF30-60M	1200	1400	1600
扶手间距 Handrail spacer	d	KLF30-60M	838	1038	1238
安全土建开口宽度 Safety construction layout opening width	e	KLF30-60M	1718	1918	2118
土建开口宽度 Construction layout opening width	f	KLF30-60M	1200	1400	1600
螺纹钢数量 (根) Threaded steel quantity (PCS)	g	KLF30-60M	4	5	6
运行速度 (m/s) Running speed (m/s)		KLF30-60M	0.5	0.5	0.5
倾斜角 (°) Degree of inclination (°)		KLF30-60M	30	30	30

说明

本图适用于10M及以下单台安装扶梯的土建施工之用。
 选用梯级宽度600mm或选用双驱动，桁架上部必须延长550mm；当H≤5.7m时，取消中间支撑。
 销售部门应将本图一式4份提供用户，其中2份经用户盖章，签字后返回技术科。
 尺寸单位为mm，个别尺寸可能有更改，如有更改，恕不另行通知。

支反力

Reacting force

R1(kN)	梯级宽度600	4.1×L2+15.5	梯级宽度800	4.5×L2+16.1	梯级宽度1000	5×L2+17.5
R2(kN)	梯级宽度600	4.1×L1+7.8	梯级宽度800	4.5×L1+7.8	梯级宽度1000	5×L1+8.5
R3(kN)	梯级宽度600	4.25×L+9.5	梯级宽度800	4.5×L+10.5	梯级宽度1000	5.2×L+11.5

L, L1, L2单位为m, L1, L2都不超过15m。
 L, L1, L2unit is m, L1, L2 will not exceed 15m.

Description

This drawing is fit for the construction of 10m and below single mounted escalators.
 It chooses 600mm wide step or double-drive. Upper truss shall extend 550mm more. When H≤5.7m, middle support shall be cancelled.
 The Sales Dept. needs to make four copies of this drawing. Two copies shall return to the Technical Section after being stamped and signed by the users.
 Size unit: mm. It is possible to change some individual sizes. If there is any alterations, advance notice won't be given then.

标准规格及尺寸

Standard specification and dimension

梯级宽度 Step width	a	KLF35-60K	600	800	1000
装饰宽度 Decoration width	b	KLF35-60K	1140	1340	1540
土建开口宽度 Construction layout opening width	c	KLF35-60K	1200	1400	1600
扶手间距 Handrail spacer	d	KLF35-60K	838	1038	1238
安全土建开口宽度 Safety construction layout opening width	e	KLF35-60K	1718	1918	2118
土建开口宽度 Construction layout opening width	f	KLF35-60K	1200	1400	1600
螺纹钢数量 (根) Threaded steel quantity (PCS)	g	KLF35-60K	4	5	6
运行速度 (m/s) Running speed (m/s)		KLF35-60K	0.5	0.5	0.5
倾斜角 (°) Degree of inclination (°)		KLF35-60K	35	35	35

说明

本图适用于6M及以下单台安装扶梯的土建施工之用。
 选用梯级宽度600mm，桁架上部必须延长550mm。
 销售部门应将本图一式4份提供用户，其中2份经用户盖章，签字后返回技术科。
 尺寸单位为mm，个别尺寸可能有更改，如有更改，恕不另行通知。

支反力及功率

Reacting force and power

R1(kN)	梯级宽度600	3.5×L+15.5	梯级宽度800	4×L+17	梯级宽度1000	4.5×L+18.5
R2(kN)	梯级宽度600	3.5×L+10	梯级宽度800	4×L+11	梯级宽度1000	4.5×L+11.5
5.5KW	梯级宽度600	3m≤H≤6m	梯级宽度800	3m≤H≤5m	梯级宽度1000	3m≤H≤4m
8KW	梯级宽度600	5m<H≤6m	梯级宽度800	5m<H≤6m	梯级宽度1000	4m<H≤5m
11KW	梯级宽度600	5m<H≤6m	梯级宽度800	5m<H≤6m	梯级宽度1000	5m<H≤6m

L单位为m, L unit is m.

Description

This drawing is fit for the construction of 6m and below single mounted escalators.
 If it chooses 600mm of the step width, it should prolong 550mm of the upper truss.
 The Sales Dept. needs to make four copies of this drawing. Two copies shall return to the Technical Section after being stamped and signed by the users.
 Size unit: mm. It is possible to change some individual sizes. If there is any alterations, advance notice won't be given then.

土建参数 General Layout Drawing Data

KLF 35° 单列 室外 Single (outdoor)
KLF35-60K / 80K / 100K 2个水平梯级 Two horizontal steps H≤6m

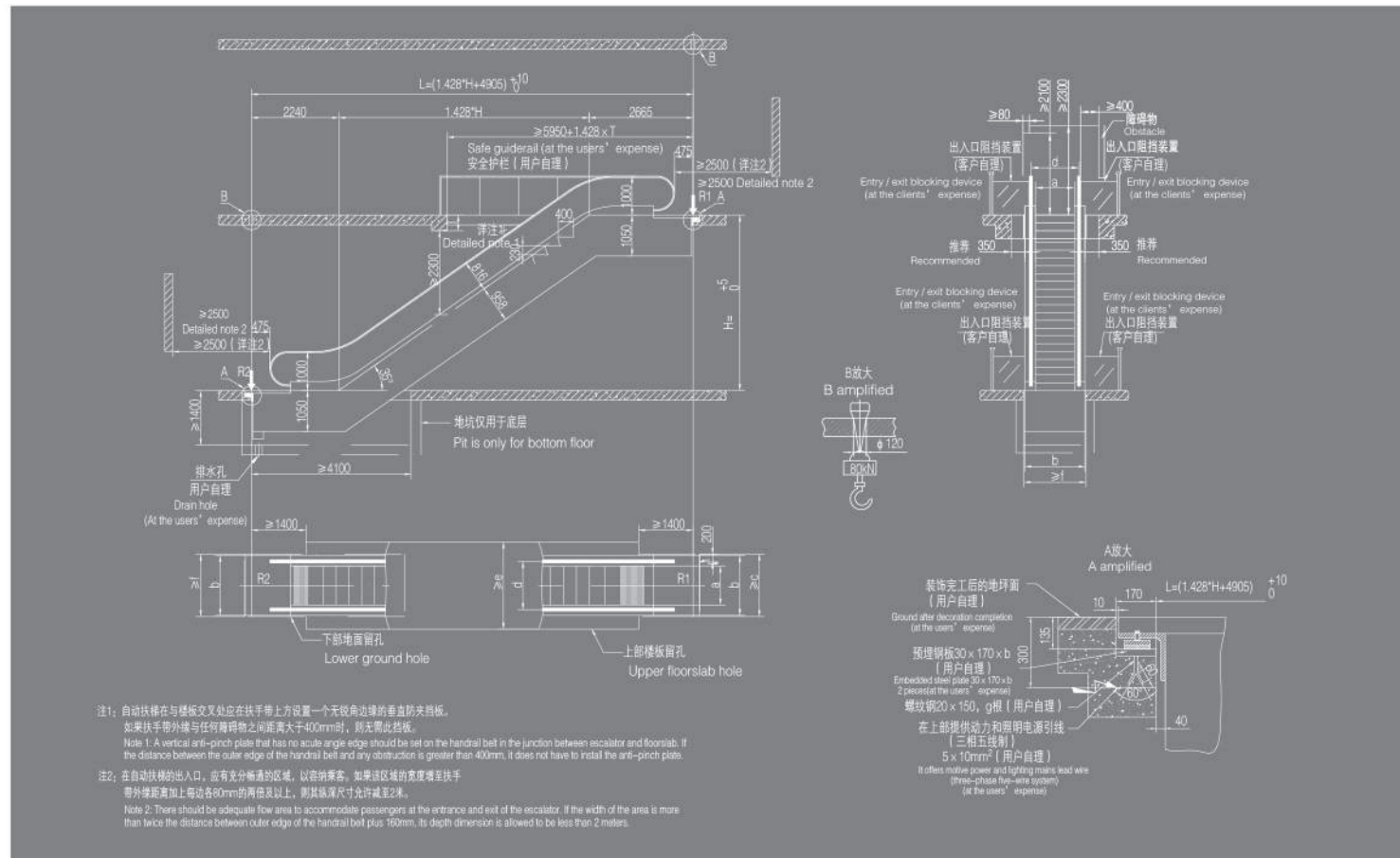

标准规格及尺寸 Standard specification and dimension

梯级宽度 Step width	a	KLF35-60K 600	KLF35-80K 800	KLF35-100K 1000
装饰宽度 Decoration width	b	1140	1340	1540
土建开口宽度 Construction layout opening width	c	1200	1400	1600
扶手间距 Handrail spacer	d	838	1038	1238
安全土建开口宽度 Safety construction layout opening width	e	1718	1918	2118
土建开口宽度 Construction layout opening width	f	1200	1400	1600
螺纹钢数量 (根) Threaded steel quantity (PCS)	g	4	5	6
运行速度 (m/s) Running speed (m/s)		0.5	0.5	0.5
倾斜角 (°) Degree of inclination (°)		35	35	35

说明

本图适用于6M及以下单台安装扶梯的土建施工之用。
选用梯级宽度600mm, 桁架上部必须延长550mm。
销售部门应将本图一式4份提供用户, 其中2份经用户盖章, 签字后返回技术科。
尺寸单位为mm, 个别尺寸可能有更改, 如有更改, 恕不另行通知。

支反力及功率 Reacting force and power

	梯级宽度 600	梯级宽度 800	梯级宽度 1000
R1(kN)	3.5×L+15.5	4×L+17	4.5×L+18.5
R2(kN)	3.5×L+10	4×L+11	4.5×L+11.5
5.5KW	3m≤H≤6m	3m≤H≤5m	3m≤H≤4m
8KW		5m < H≤6m	4m < H≤5m
11KW			5m < H≤6m

L单位为m。 L unit is m.

Description

This drawing is fit for the construction of 6m and below single mounted escalators.
If it chooses 600mm of the step width, it should prolong 550mm of the upper truss.
The Sales Dept. needs to make four copies of this drawing. Two copies shall return to the Technical Section after being stamped and signed by the users.
Size unit: mm. It is possible to change some individual sizes. If there is any alterations, advance notice won't be given then.

全国分公司服务网络 National Branch Service Network

辽宁分公司

销售热线: 024-31981333 传真: 024-31981222
地址: 沈阳市大东区滂江街26-1国际公寓2916

大连分公司

销售热线: 0411-86552277 传真: 0411-86552299
地址: 大连市中山区民康街15号报业大厦16层E

盘锦分公司

销售热线: 0427-2828611 传真: 0427-2829611
地址: 辽宁省盘锦市兴隆台区大商新玛特C座2102室

黑龙江分公司

销售热线: 0451-82346098 传真: 0451-82318292
地址: 黑龙江省哈尔滨市道里区群力第四大道399号汇智广场西楼1004室

吉林分公司

销售热线: 0431-86770000 传真: 0431-81030300
地址: 长春市经济技术开发区滨河街5445号圣豪汇商705室

北京分公司

销售热线: 010-65505559 传真: 010-65505562
地址: 北京市朝阳区八里庄西里97号住邦2000商务中心4号楼10层

内蒙古分公司

销售热线: 0471-6289116 传真: 0471-6922767
地址: 呼和浩特市回民区新华西街明泽广场A座21层2110室

河北分公司

销售热线: 0311-66792031 转 8002 传真: 0311-87893130
地址: 石家庄市建设南大街29号众鑫大厦818-820室

天津分公司

销售热线: 022-58306090 传真: 022-58306091
地址: 天津市红桥区光荣道与保康路交口宝能创业中心B座24层2412室

山西分公司

销售热线: 0351-8371869 传真: 0351-8371859
地址: 太原市小店区平阳路1号金茂国际数码中心A座16层F室

陕西分公司

销售热线: 029-88332244 传真: 029-88332244-831
地址: 西安市莲湖区唐延路北段22号金辉国际广场11层

甘肃分公司

销售热线: 0931-8811752 传真: 0931-8432645
地址: 甘肃省兰州市城关区澳兰名门B2座708室

新疆分公司

销售热线: 0991-4815313 传真: 0991-4815795-815
地址: 新疆乌鲁木齐沙依巴克区友好北路793号高地中心1105室

河南分公司

销售热线: 0371-60189221
地址: 郑州市郑东新区康平路永平路郑东商业中心写字楼一号楼17楼1707

山东分公司

销售热线: 0531-55693961 传真: 0531-55693965
地址: 济南市市中区经四路13号万达广场C座办公楼2606室

青岛分公司

销售热线: 0532-68890088 传真: 0532-89092106
地址: 青岛市市北区山东路177号鲁邦广场B座1106-1107

烟台分公司

销售热线: 0535-6887005 传真: 0535-6887005
地址: 山东省烟台市莱山区银海路566号南山世纪华府13-2-2802

南京分公司

销售热线: 025-58812988 传真: 025-84519155-81
地址: 南京市洪武路359号福鑫大厦西2602室

苏州分公司

销售热线: 0512-65166725 传真: 0512-65166721
地址: 苏州工业园区苏虹中路225号星虹国际1幢2113室

无锡分公司

销售热线: 0510-85861251 传真: 0510-85861252
地址: 无锡市滨湖区梁青路58号华邨国际大厦A座1501室

徐州分公司

销售热线: 0516-83919000 传真: 0516-83919005
地址: 徐州市庆丰路绿地城市广场瀛海写字楼A座706室

上海分公司

销售热线: 021-62828058/62827558 传真: 021-62828360
地址: 上海市延安西路1221号2203室

浙江分公司

销售热线: 0571-89971040 传真: 0571-86590365
地址: 杭州市新塘路19号采荷嘉业5幢1204室

安徽分公司

销售热线: 0551-62671797 传真: 0551-62313639
地址: 安徽省合肥市蜀山区望江西路69号西湖国际广场A座603室

芜湖分公司

销售热线: 0553-3856158
地址: 芜湖市镜湖区长江中路66号 徽商财富广场北楼1802室

江西分公司

销售热线: 0791-88223016 传真: 0791-88399056
地址: 南昌市高新区紫阳大道绿地新都会紫峰(幢)大厦写字楼34层3402室

湖北分公司

销售热线: 027-82660063 传真: 027-85770699
地址: 武汉市江汉区淮海路中段泛海国际SOHO城2605-2606室

襄阳分公司

销售热线: 0710-3287220 传真: 0710-3287220
地址: 襄阳市高新区长虹北路万达广场1栋二单元1902室

湖南分公司

销售热线: 0731-85787755 传真: 0731-85787722
地址: 长沙市岳麓区岳麓大道57号奥克斯广场B座1127-1129

重庆分公司

销售热线: 023-67877015 传真: 023-67877025
地址: 重庆市渝中区大坪正街160号万科锦程1栋26-6

四川分公司

销售热线: 028-61320037 传真: 028-87321179
地址: 四川省成都市高新区新世纪环球中心西区8-1-1707

云南分公司

销售热线: 0871-68355199 传真: 0871-68355299
地址: 云南省昆明市五华区人民中路36号如意大厦11A室

贵州分公司

销售热线: 0851-86515286 传真: 0851-86515286转81
地址: 贵阳市观山湖区金阳南路6号世纪城购物中心D栋写字楼23层5号

广西分公司

销售热线: 0771-5517626 传真: 0771-5505713
地址: 南宁市民族大道92-1号新城国际1401号

广东分公司

销售热线: 020-38021060 传真: 020-38021410
地址: 广州市天河区天河路625号天娱广场东塔1007-1008室

深圳分公司

销售热线: 0755-83865618 传真: 0755-83865618
地址: 深圳市福田区益田路3008号皇都广场A座1906室

珠海分公司

销售热线: 0756-2260550 传真: 0756-2260695
地址: 珠海市香洲区银桦路102号6栋优特科技大厦909室

福建分公司

销售热线: 0591-88596982 传真: 0591-88594630
地址: 福州市五一中路88号平安大厦21G